

# Insulated container CARGO 500 CATERING 3/3/2023 REV0



**ATP**



## Insulated container for the transport of products of temperature-controlled products









- Brand: MELFORM
- Country of origin: ITALY
- Customs code: 39231090
- ATP Certificate
- Compatible with food contact
- Color: light blue
- Capacity: 500 liters.
- Technology: rotomoulding
- Warranty: 24 months
- Fully recyclable at the end of its operational life.

### MANUFACTURING MATERIALS

<b>Polyethylene</b>	inner and outer walls of container and door; suitable for food contact	<b>Polyurethane</b>	insulating material between the walls of the container and the door, free of CFC and HCFC
<b>Silicone rubber</b>	gasket	<b>Nylon</b>	wheels
<b>Galvanized steel</b>	wheel support, hinge rod	<b>Stainless steel</b>	handling handles, closing handle, inner door rod, GN adapters

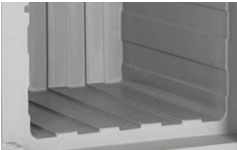
Model	Code	EAN code	Ext. dim. (mm)	Int. dim. (mm)	Capacity (liters)	Weight (kg)
Cargo 500 catering with wheels and GN adapters	05000086	8022949163426	715X850Xh1675	540x660xh1370	500	108

## PRODUCT FEATURES

	<p>4 wheels diameter 100 mm (2 fixed and 2 swivel, one of which has a brake). Wheel support plate integrated in the container.</p>		<p>Internal adapters to house GN pans</p>
	<p>Stainless steel closing handle with release button.</p>		<p>Handle prepared for the use of tamper-evident system.</p>
	<p>Eutectic plates to increase thermal maintenance performance over time (on request).</p>		<p>Available (on request) towing set to move more than one container at the same time.</p>
	<p>Internal temperature controllable thanks to the thermometer that can be inserted into the door (on request).</p>		<p>GN polycarbonate pans of various heights, on request. Exclusive Melform design.</p>
	<p>Internal grooves to promote good air circulation.</p>		<p>Openable door up to 270° with latch - tab door.</p>
	<p>Door sealing gasket easily removable</p>		<p>Stainless steel rod with 2 hooks integrated inside the door.</p>
	<p>Monobloc structure, without edges, joints and welds.</p>		<p>Insulation with CFC and HCFC free polyurethane foam.</p>

## CONTAINER TECHNICAL DATA (mm)

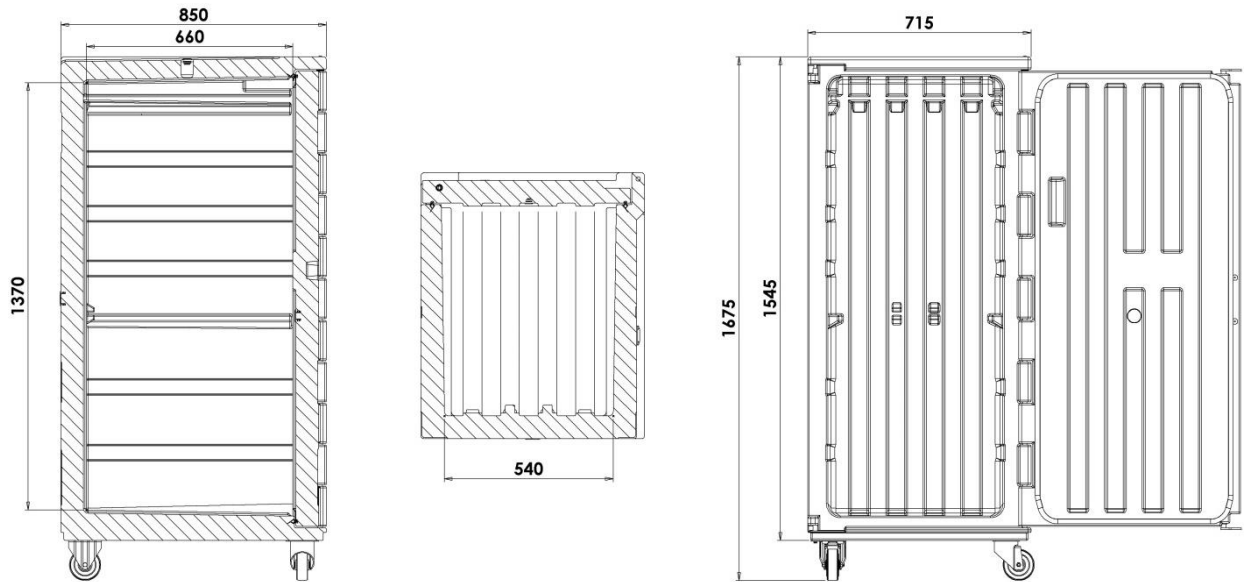

## ADAPTERS FOR GN PANS

**H65**

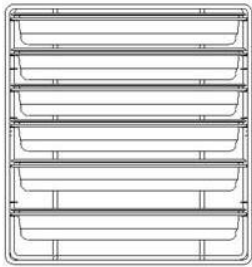
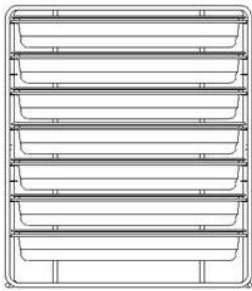

Capacità: 26 unità

**H100**



Capacità: 20 unità

**H150**

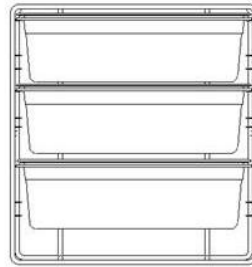
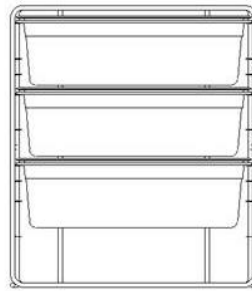

Capacità: 12 unità

**H200**

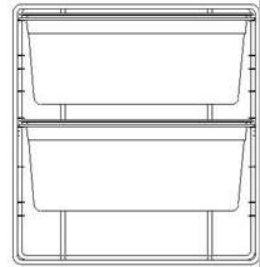
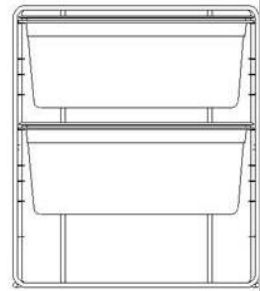

Capacità: 8 unità

## ACCESSORIES

Model	Code	Color	Ext. Dim. (mm)	Int. Dim. (mm)	Weight (kg)
Card holders	AMC101	transparent	173xh200	148xh210 -A5-	
GN lower adapter 9 guides	AAA054	stainless	555x650xh585		9
GN upper adapter 9 guides	AAA055	stainless	555x650xh685		9