



Insulated container for the transport of meals at controlled temperature







- Brand: MELFORM
- Country of origin: ITALY
- Customs code: 39231090
- Compatible with food contact
- Technology: rotomoulding
- Warranty: 24 months
- Fully recyclable at the end of its operational life.

MANUFACTURING MATERIALS

Polyethylandne	internal and external walls of the base and lid; suitable for food contact	Polyurethane	insulating material between the walls of the base and cover; CFC and HCFC free
Glass fiber reinforced polyamide	closures		

Model	Product Code	EAN code	External dimensions (mm)	Weight (kg)
Malinette melange	MAL10006	8022949016272		
Malinette blue	MAL10001	8022949016227	340x340xh170	2.2
Malinette red	MAL10004	8022949016258		

PRODUCT FEATURES

	<p>Characterized by a practical and effective closing system, consisting of two closing hooks in shockproof material.</p>		<p>Equipped with integrated grip handle.</p>
	<p>Equipped with 4 compartments perfectly insulated from the thermal point of view.</p>		<p>Stainless steel pans available, on request to be used directly on the flame.</p>
	<p>The isothermal energy of the tray ensures thermal maintenance even if the user is not present at the distribution of the meal.</p>		<p>Dishwasher safe.</p>
	<p>Monobloc structure, without edges, joints and welding.</p>	<p>°C</p>	<p>Granted for use: from -30°C to +100°C.</p>

TECHNICAL DATA (mm)

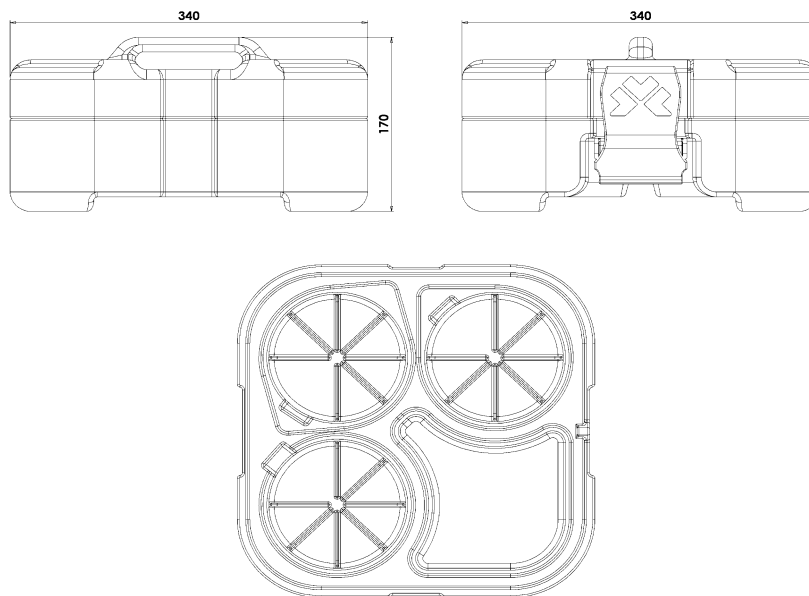

ACCESSORIES

Model	Code	Color	External dimensions (mm)	Capacity (liters)	Weight (kg)
Oven/flame pan	ACA002	stainless steel	Diam. 125xh69	0,6	0,56