

1100x1100



Insulated container for the transport of temperature-controlled products













- Brand: MELFORM
- Country of origin: ITALY
- Customs code: 39231090
- External dimensions 1100x1100
- Compatible with food contact
- Color: melange grey/blue
- Capacity: 1350 liters.
- Technology: rotomoulding
- Warranty: 24 months
- Fully recyclable at the end of its operational life.

MANUFACTURING MATERIALS

Polyethylene	inner and outer walls of container and door; suitable for food contact	Polyurethane	insulating material between the walls of the container and the door, free of CFC and HCFC
Silicone rubber	gasket	Nylon	wheels
Polypropylene	Hinges	Stainless steel	handling handles, closing handle, internal door rod
Galvanized steel	Hinge rods, hinge rod connection plates, wheel support		

Model	Code	EAN code	Ext. dim. (mm)	Int. dim. (mm)	Capacity (liters)	Weight (kg)
Cargo 1300TW wheels	1300T003	8022949120610	1100x1100xh1940	900x910xh1580	1350	150
Cargo 1300TW feet	1300T009	8022949138202	1100x1100xh1905	900x910xh1580	1350	150

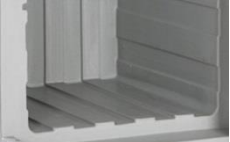
PRODUCT FEATURES

	<p>Equipped with 4 wheels. diam. 125mm, two fixed, one swivel and one swivel with brake. Wheel support plate integrated in the container</p>		<p>Version with 4 feet in galvanized steel h 120mm</p>
	<p>4 housing seats of grids positioned at 385/785/1185/1290mm from the bottom of the container</p>		<p>Grids in stainless steel (on request)</p>
	<p>Label holder for identification of the content or destination. Suitable for B5 format documents</p>		<p>Stainless steel closing handle with release button and tamper-evident system</p>
	<p>Internal temperature controllable thanks to the thermometer that can be inserted into the door (on request)</p>		<p>Available (on request) USB datalogger to record temperature data during transport</p>
	<p>2 stainless steel seats, positioned 135mm from the roof of the container, allow the housing of 4 eutectic plates</p>		<p>Fresh, frozen and frozen plus eutectic plates, to increase thermal performance over time (on request)</p>
	<p>Door can be opened up to 270° with double tab and magnetic door retainer</p>		<p>Door sealing gasket easily removable</p>
	<p>Internal grooves to promote good air circulation</p>		<p>Double pin hinges. Improved stability of the door over time</p>
<p>K</p>	<p>Overall heat transfer coefficient: K=0.33 W/m²K</p>	<p>°C</p>	<p>Guaranteed for use: -30°C to +100°C</p>

TECHNICAL DATA (mm)

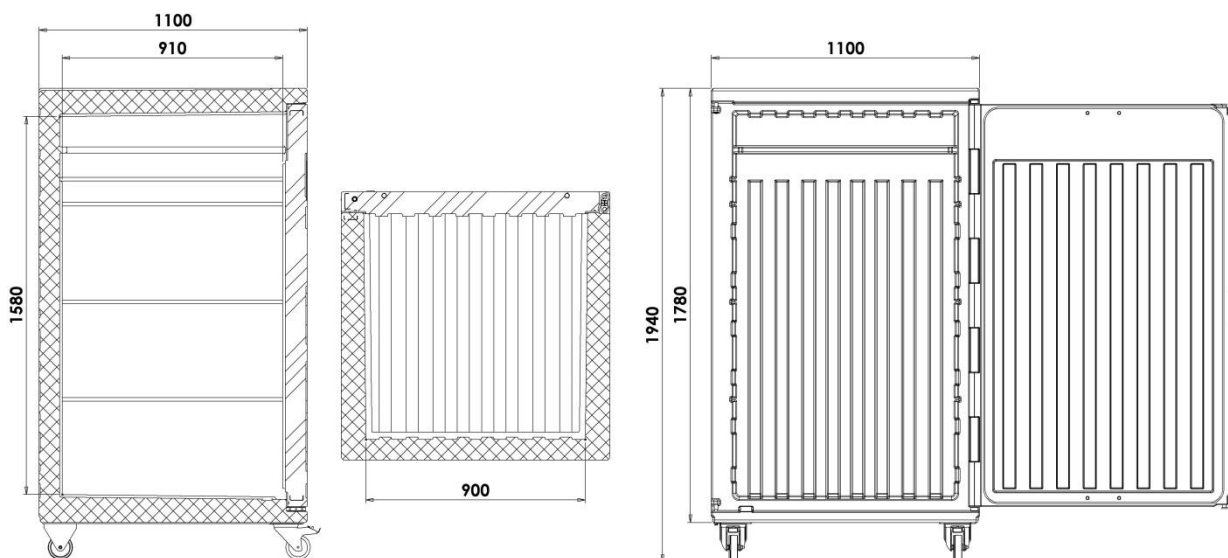

ACCESSORIES

Model	Code	Color	Ext. dim. (mm)	Int. dim. (mm)	Weight (kg)
Label holders	AMC103	transparent	285x160Xh2	250x176h -B5-	
Grid stainless steel	AEA024	stainless steel	935x890xh16		7
Eutectic plate Fresh +3°C - 4 x Cargo -	PE110001	rose	835x353xh45		7,6
Eutectic plate Frozen -21°C - 4 x Cargo -	PE110002	blue	835x353xh45		7,6
Eutectic plate Frozen Plus -21°C - 4 x Cargo -	PE119008	green	835x353xh45		7,6
Data logger USB	AFG007		80x33xh14		